

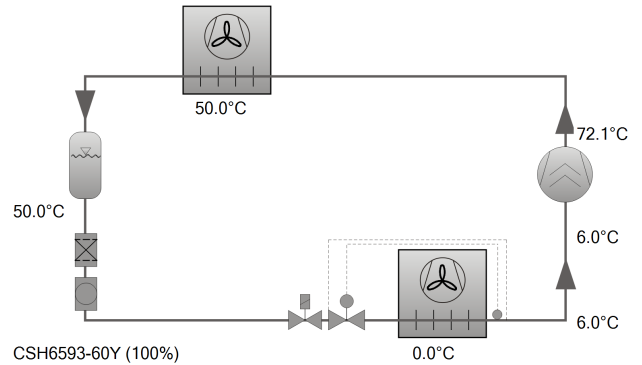

### Selection: Compact Screw Compressors CS // CSV

#### Input Values

Compressor model	CSH6593-60Y
Refrigerant	R134a
Reference temperature	Dew point temp.
Evaporating SST	0 °C
Condensing SDT	50.0 °C
Liq. subc. (in condenser)	0 K
Suct. gas superheat	6.00 K
Useful superheat	100%
Operating mode	Standard
Power supply	400V-3-50Hz
Capacity control	100%
Additional cooling	Automatic
Max. discharge gas temp.	110.0 °C



#### Result

<b>Compressor</b>	<b>CSH6593-60Y-40P</b>
Capacity steps	100%
Cooling capacity	98.6 kW
Cooling capacity *	99.4 kW
Evaporator capacity	98.6 kW
Power input	34.8 kW
Current (400V)	61.7 A
Voltage range	380-415V
Condenser capacity	133.4 kW
COP/EER	2.84
COP/EER *	2.86
Mass flow LP	2700 kg/h
Mass flow HP	2700 kg/h
Operating mode	Standard
Liquid temp.	50.0 °C
Oil volume flow	0.49 m³/h
Cooling method	--
Discharge gas temp. w/o cooling	72.1 °C

\*According to EN12900 (10K suction gas superheat, 0K liquid subcooling, see tech. data/ notes)

### Application Limits Standard CSH6593-60

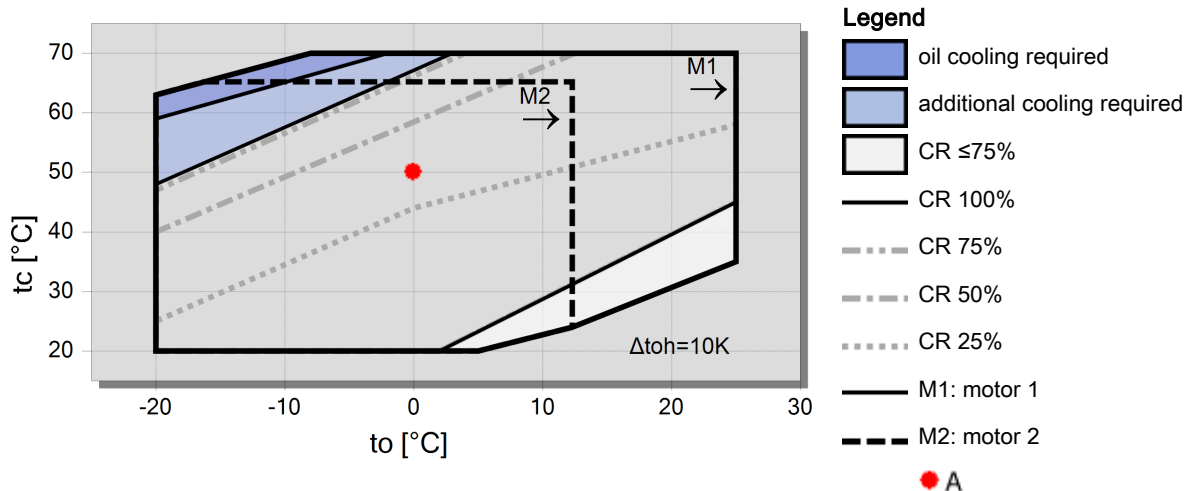



## Technical Data: CSH6593-60Y

### Dimensions and Connections

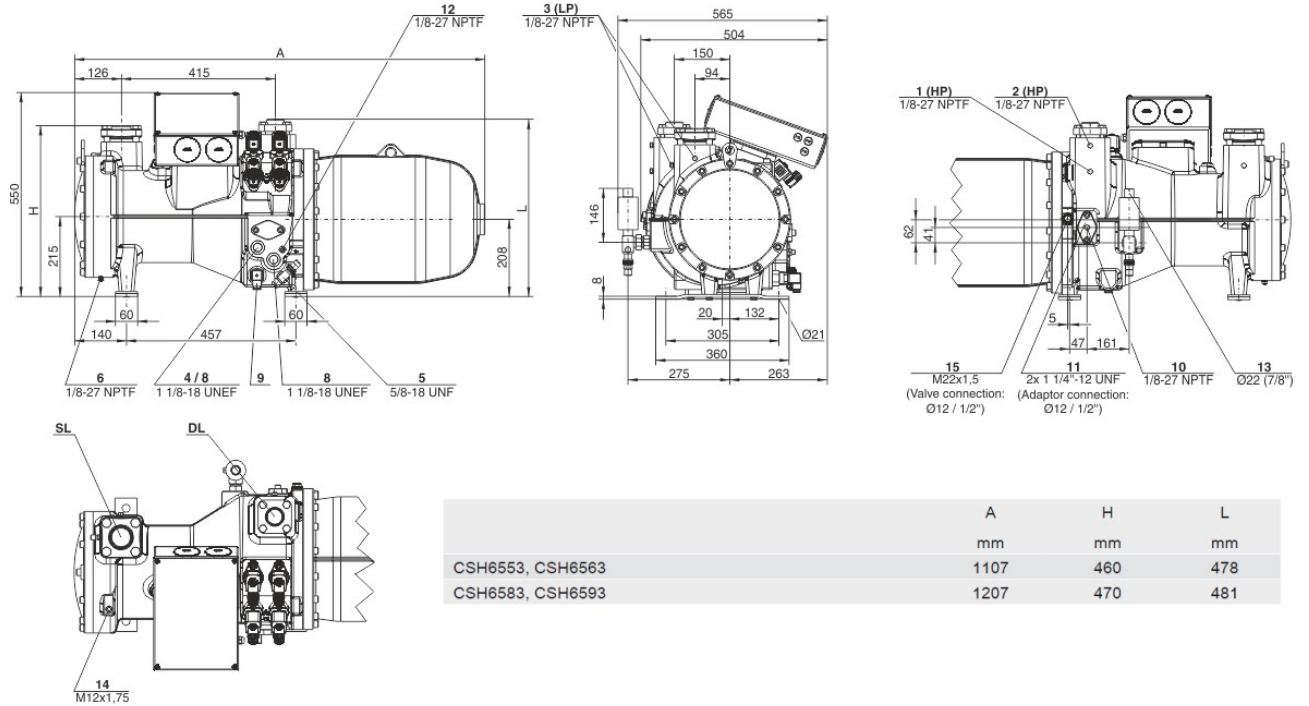



## Technical Data

### Technical Data

Displacement (2900 RPM 50 Hz)	220 m <sup>3</sup> /h
Displacement (3500 RPM 60 Hz)	264 m <sup>3</sup> /h
Weight	365 kg
Max. pressure (LP/HP)	19 / 28 bar
Connection suction line	64 mm - 2 5/8"
Connection discharge line	54 mm - 2 1/8"
Oil type R1234yf/R1234ze(E)/R450A/R513A/R515B	BSE170 (Option)
Oil type R134a/R407C/R404A/R507A/R407A/R407F	BSE170 (Option)
Oil type R22	B320SH (Standard)

### Motor data

Motor version	2
Motor voltage (more on request)	380-415V PW-3-50Hz
Max operating current	108.0 A
Winding ratio	50/50
Starting current (Rotor locked)	269.0 A D / 508.0 A DD
Max. Power input	56.0 kW

### Extent of delivery (Standard)

Enclosure class	IP54
Oil heater	200 W (Standard)
Oil separator	Standard
Oil filter	Standard
Discharge gas temperature sensor	Standard
Start unloading	Standard
Capacity Control - 4-step	100-75-50-25% (Standard)
Capacity Control - infinite	100-25% (Standard)
Built-in check valve	Standard
Motor protection	SE-E1 (Standard), SE-E3(Standard for 660-690V)
Oil charge	9,0 dm <sup>3</sup>

### Available Options

Oil level switch	min / max OLC-D1-S (Option)
Discharge shut-off valve	Option
Suction shut-off valve	Option
Shut-off valve for ECO with muffler	Option
Liquid injection with integrated nozzle	Option
Bridges for DOL start	Option
with sound jacket	Option
Vibration dampers	Option
Motor protection	SE-i1 (200-690V)



## Compact Screw Compressors CS

### Reference points for evaporating and condensing pressures

Connection positions 1 (HP) and 3 (LP) on the compressor (see dimensions). The pressure drop for shut-off valves and check valves has not been taken into consideration. This is the worldwide state of the art for compact screws, as in factory-produced chillers shut-off valves are often omitted and the check valve can also be arranged as an external component in the discharge line. For the sake of the international comparability of performance data, this standard has been adopted for the screw compressors of the CSH/CSW/CSVH series.

### ASERCOM certified performance data

The Association of European Refrigeration Component Manufacturers has implemented a procedure of certifying performance data. The high standard of these certifications is assured by:

- \* plausibility tests of the data performed by experts.
- \* regular measurements at independent institutes.

These high efforts result in the fact that only a limited number of compressors can be submitted. Due to this not all BITZER compressors are certified up to now. Performance data of compressors which fulfil the strict requirements may carry the label "ASERCOM certified". In this software you will find the label at the respective compressors on the right side below the field "result" or in the print out of the performance data. All certified compressors and further information are listed on the homepage of ASERCOM.

### Legend of connection positions according to "Dimensions":

- 1 High pressure connection (HP)
  - 2 Additional high pressure connection
  - 3 Low pressure connection (LP)
  - 4 Oil sight glass
  - 5 Oil valve for maintenance (standard) / connection for oil equalisation (parallel operation)
  - 6 Oil drain plug (motor housing)
  - 7 CSH only, except CSH6583, CSH6593, CSH95103 and CSH95113: Connection for electro-mechanical oil level switch in case of replacing a CSH.1 by a CSH.3
  - 8 Connection for opto-electronical oil level switch (OLC-D1-S) CSVH: integrated into FI control  
CS.105: connected to monitoring module
  - 9 Oil heater with sleeve (standard) CSVH: integrated into FI control  
CS.105: connected to monitoring module
  - 10 Oil pressure connection
  - 11 External oil cooler connections (adaptor optional)
  - 11a outlet to oil cooler
  - 11b inlet / return from oil cooler
  - 12 Oil temperature sensor (PTC) CSVH: integrated into FI control  
CS.105: connected to monitoring module
  - 13 Economiser connection (ECO) (shut-off valve optional CSH: with pulsation muffler)
  - 14 Threaded bore for pipe support  
CS.L line for ECO or LI  
CSVH:  
14a line for ECO  
14b line for FI cooling
  - 15 Liquid injection connection (LI) (CSH: shut-off valve optional)
  - 16 Earth screw for housing
  - 17 Connection for oil and gas return (for systems with flooded evaporator adaptor optional)
  - 18 Oil filter (maintenance connection)
  - 19 FI cooling (liquid refrigerant)
  - 20 Frequency inverter (FI)
  - 21 Oil injection valve (internal)
  - 24 Gas permeable plug
  - SL Suction gas line
  - DL Discharge gas line
- Dimensions can show tolerances according to EN ISO 13920-B.